

# LED HIGH BAY HB2000-80



- Clamping Technology applied LED high bay
- High luminous efficacy (160 lm/w)
- LED replacement for MH 250 W with 68% electricity saving
- Installable vertically and horizontally at any angle
- Various cover options and mounting options are available
- Various beam angle are available with cover lens
- [Option] Dimming : 3 in 1 Dimming Control (0-10V, PWM, Resistance)
- Ultraviolet free, no mercury and lead-free RoHS Compliance



## SPECIFICATION

### ELECTRICAL

Wattage	80 W
Power Input	AC 120 - 277 V
Frequency	50/60 Hz
Power Factor (PF)	> 0.96
THD	< 15%
Protection Circuit	4 kV

### CONSTRUCTION

Size	ø 276 x 146 mm
Weight	2.1 kg
Material	Polycarbonate
Heatsink	Copper ICEPIPE Heatsink
Operating Temperature	-30°C ~ 50°C (-22°F ~ 122°F)
Installation Angle	360°

### OPTICS

Lumen output	12,800 lm
Efficacy	160 lm/W
Replacement	MH 250 W
CCT	5,700 K
LED Package Life time	50,000 hours (25°C) <small>*LED package life time according to industry standard (LM80). *High operating temperature may shorten life span of LED package and LED lamp.</small>
CRI	80 Ra

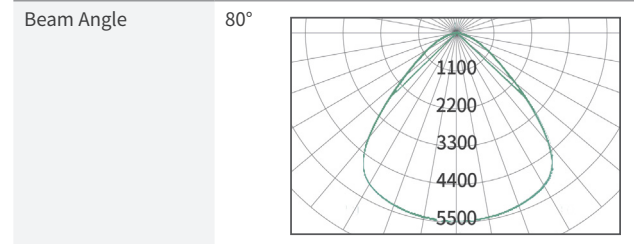

## ICEPIPE HEATSINK

### Highly Efficient ICEPIPE heatsink

ICEPIPE heatsink was created by our patented Fluid Dynamic Pressure Technology, which enables heat dissipation 200 times faster (40,000 W/m·K) than that of conventional aluminum (Al) heatsink. Liquid circulation takes place inside the pipe, traveling through the coil and cooling down heat from the LEDs in the most efficient way.

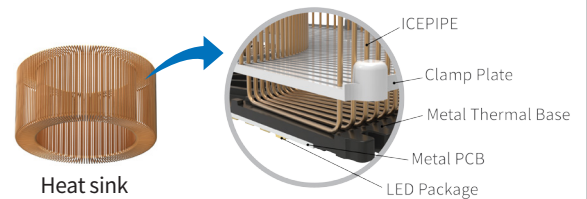

- The fastest heat transfer rate
- Efficient air flow
- Uses light weight copper

## APPLICATION



Factory



Gymnasium





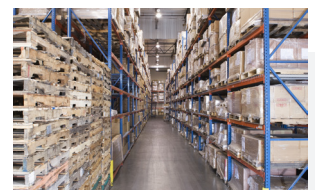

Auditorium







Warehouse

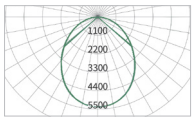
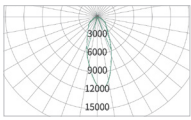
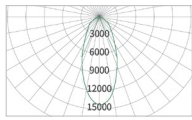
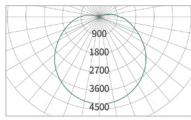
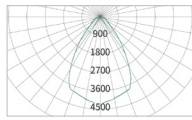

## COVER OPTIONS

Cover					
	Diffuser Cover	Cover Lens		Dome Diffuser	Reflector
LIGHT DISTRIBUTION CURVE					
Beam Angle	97°	45°	60°	130°	65°

## INSTALLATION TYPE

					
Chain	FMB Pipe Bracket	GS Bracket	Hinge Bracket	60D Hinge Bracket	90D Hinge Bracket

## [Option] Dimming

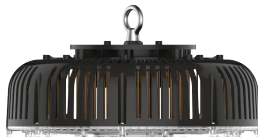

Dimmer



Sensor



Gateway

- 0 / 1-10V / PWM / resistance dimming
- Motion/daylight sensor
- Wireless/wired control applicable

## PACKING

Type	Single Unit Box	Pallet	20ft Container-Palletized	Remarks
Quantity	1	90	900 (10 Pallets)	3R x 3R x 10L = 90 pcs
Dimension(mm)	315 x 315 x 181	1,100 x 1,100 x 1,960	5,500 x 2,200 x 1,960	
GWT(kg)	2.62	253	2,530	
CBM	0.018	2.37	23.70	

## ⚠ WARNINGS

- Do not use with direct current and ballast.
- Do not install the lamp in an enclosed place.
- Do not install on any other shade that is not provided by ICEPIPE.
- Please follow the recommended daily operating hours.
- Please read the instruction manual carefully before installation.



\* Please refer to our full warranty terms and contact your sales representative for details.

